



Sust 250 Injection Cycle - Sustanon 250 Cycle (Sustanon Guide) - Steroid Cycles

Sustanon 250 Only Cycle Beginners using Sustanon alone in a cycle can start from 300mg to 500mg weekly with 12 weeks being the minimum length for this cycle, while advanced users will choose to take to three times that dosage during a 12 week

=====

🔗 Injectables AAS / Oral AAS / HGH / Weight Loss / Peptides / Post Cycle Ttherapy

🔒 High Quality / Secured Payment / Guaranteed Confidentiality / Private Data Protection

? Customer support / International shipping / Secure & private

🔥 VISIT OUR SHOP: <https://t.co/zgHxDZhbzyz>

=====

How Often Do You Need to Inject Sustanon 250? Like Testosterone enanthate, Sustanon 250 can be injected once or twice per It is always advisable to opt for the original Organon product (pharmaceutical grade) and avoid underground versions that try to mimic the Sustanon Sustanon 250 is usually fairly easy and inexpensive to

Sustanon Cycle: Sustanon 250 Cycle for Beginners in 2021

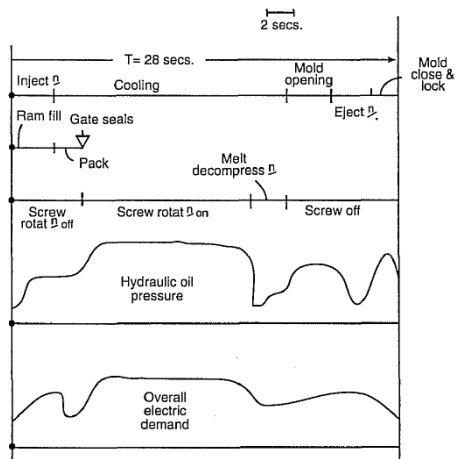

Representative timing diagram, with pressure and electrical power demand profiles for a 28-s machine cycle.

Once Sustanon 250 leaves your system completely, users can perform the four week PCT This will prevent you from the various possible side effects that occur due to Sustanon Users can use Clomid, HCG and Nolvadex to perform the PCT Conclusion Sustanon 250 is both slow and fast-acting ester

variants of

A Comprehensive Guide To Sustanon 250 Cycles - Lee-Jackson



Beginners prefer a sustanon 250 only In such a cycle, the dose is between 200 mg to 350 mg per week and the cycle time is for 12 Sample Cycle 1 A beginner can start with a 7-week cycle with 200 mg for the first two weeks, increase it to 300 mg for the next three weeks, and then to 350 mg for the last two Sample Cycle 2

The truth on sustanon 250 Injection - Sustanon Steroids



The cycle is for nine weeks; for the first week, you can take 250 mg, 500 mg for the next six weeks, and for the rest of the week, you can take 250 Thus, further taking the same dosage of 250 mg will help you in building your But, remember taking this injection does have side effects as

Sustanon 250 for 6 weeks, sustanon 250 cycle dosage bodybuilding

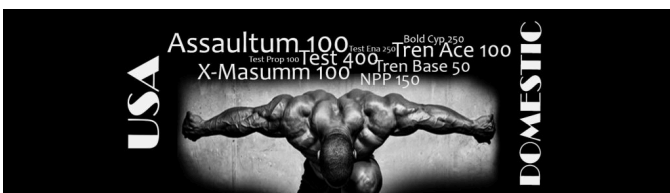

Sustanon '250' (250 mg/ml solution for injection) The standard starting dose is one injection containing

200-250 mg of testosterone every 2-3 Testosterone injections which are administered every two weeks are known as short-acting injectable testosterone (And provide testosterone replacement for around six

How Often Do you Inject Sustanon 250? - Sustanon Steroids



Le cycle idéal de Sustanon est de 8 à 10 Rappelez-vous, ne dépassez jamais la limite d'une dose élevée; si vous prenez plus de 1000 mg par semaine, vous faites face à divers effets Généralement, les injections de Sustanon 250 sont injectées une ou deux fois par

Sustanon 250 Deca Durabolin Cycle - Sustanon Steroid Injection



Sustanon 250 and Deca Durabolin This is a powerful bulking cycle, yet one of the mildest stacks in terms of side This cycle may be utilized after running several testosterone cycles; promoting further muscle Deca durabolin has long esters and thus is a slow-acting steroid, hence the lengthy 10 week -> <-

Upping my sust 250 dose?

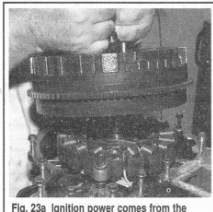

Fig. 23a Ignition power comes from the magneto comprised of the flywheel-mounted magnets and...

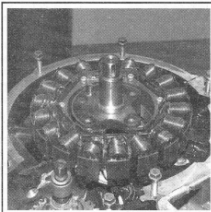

Fig. 23b ...the stator coil windings mounted under the flywheel

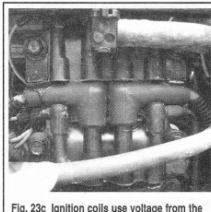

Fig. 23c Ignition coils use voltage from the EHM to induct high voltage that fires the spark plugs

#1 I started out at 250mg IMI every 3rd day which is what made me feel the most stable, I increased my dose after 8 weeks to 375mg every 3rd Sust 250 is my favorite ester due to giving me the most energy, would it be pretentious to keep it at roughly 750mg a week for the rest of the cycle? Ironpirate Active member Awards 4 Oct 31, 2021 #2

Sustanon - injection frequency? | MESO-Rx Forum



Greetings fellow BBs, Need some advice on Sustanon I'm currently running a cycle of 613 mg Test E and 210 mg Tren However, it's been more than four weeks now and since I am someone who tolerates Tren very well as well as high doses of Test, I've decided that I'm going to bump the Tren up to 350 mg and the Test up to 832 mg using Sust as an

You All Want to Know About Sustanon 250 Cycles

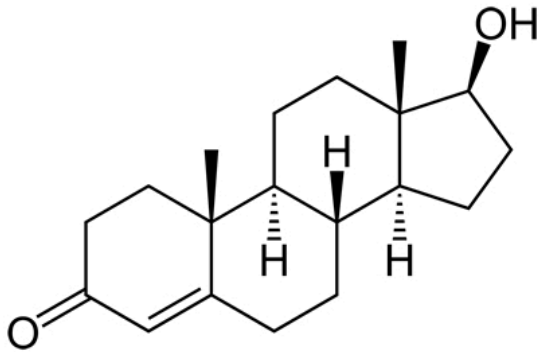

Beginner Users can start with 250 mg to 500 mg per Intermediate Users can start with 500 mg to 750 mg per Advanced level Users can start with 750 mg to 1000 mg per The typical Sustanon 250 cycle is eight to ten Users can perform the below cycle based on their experience levels and individual goals:

Deca-Durabolin Cycle (Deca Cycle Guide) - Steroid Cycles

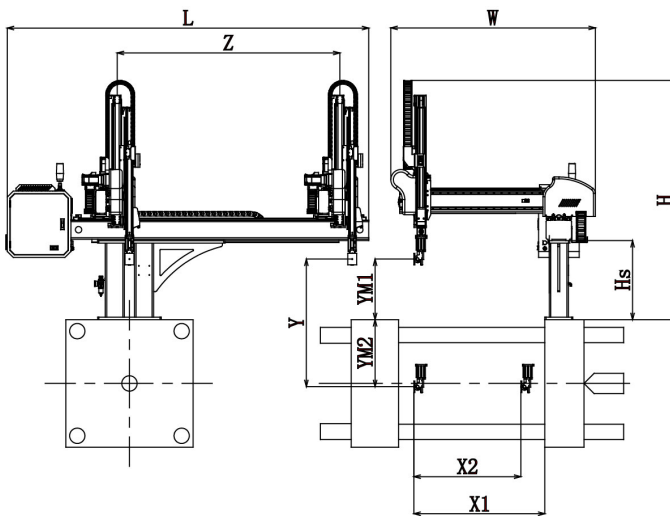

Testosterone Enanthate and Deca is a common combination with a cycle length of 12 to 14 Deca at 200mg to 300mg per week will prove highly effective for any beginner, with Testosterone Enanthate at up to 500mg weekly is a necessary addition to ensure testosterone levels are

Sustanon 250 La Pharma - Sustanon 250 Injection Cycle

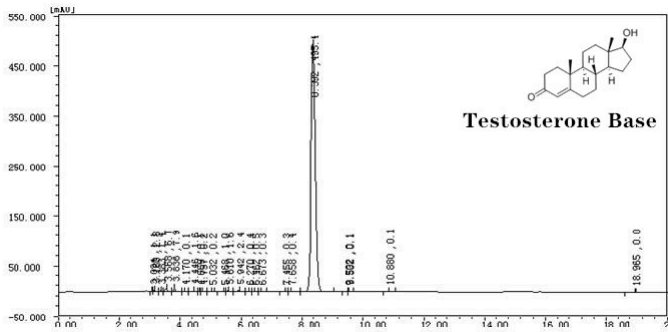

Sustanon 250 is a clear pale yellow solution for injection containing the active ingredient testosterone in 4 (250 mg/ml) separate The active substances of Sustanon 250 (see section 6 "What Sustanon 250 contains") are turned into testosterone by your Testosterone is a natural male hormone known as an

Steroid Cycles - Anabolic Basics for Beginners (The Guide)

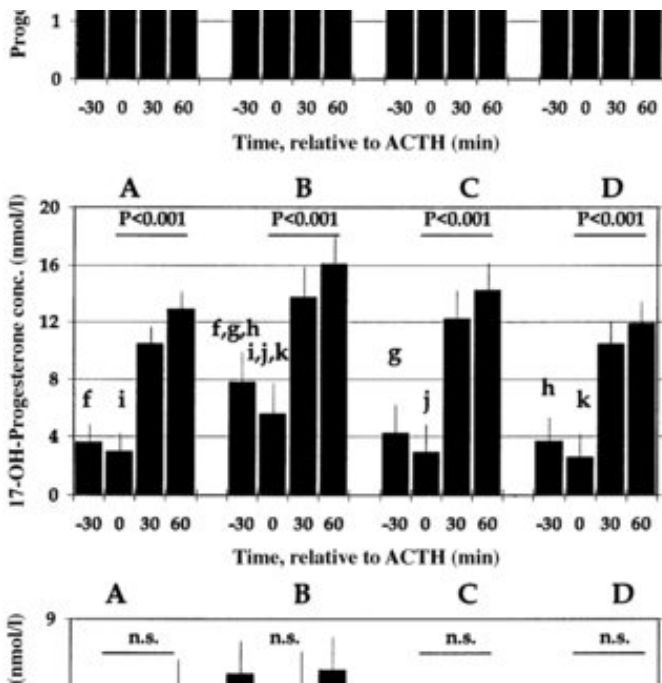

Sustanon 250 (Testosterone Propionate, Phenylpropionate, Isocaproate, Decanoate): 15-18 days, (3 months), 100/100 - Sustanon 250 is a group of both slow and fast acting esters and that makes it useful for contributing to muscle building, fat loss, energy and strength by providing critical testosterone support during a steroid

Sus 250 Injection Site - Sustanon 250 Cycle (Sustanon Guide)

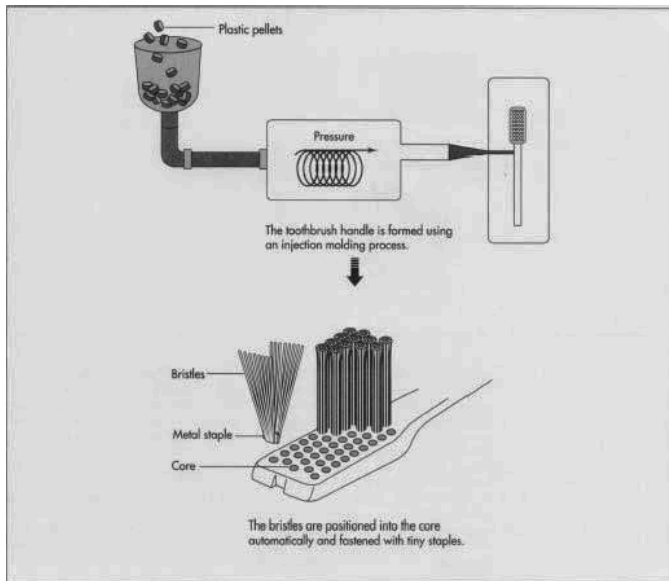

For Sustanon 250 this is about 2-3 How to make an injection? Clean the vial: wipe the rubber on top of the vial with alcohol and wait about a Pull as much air into the syringe as you intend to draw oil (this will prevent vacuum from forming in the vial) Insert the needle and put all the air into the

Sustanon 250 injection : A treatment to boost low testosterone levels

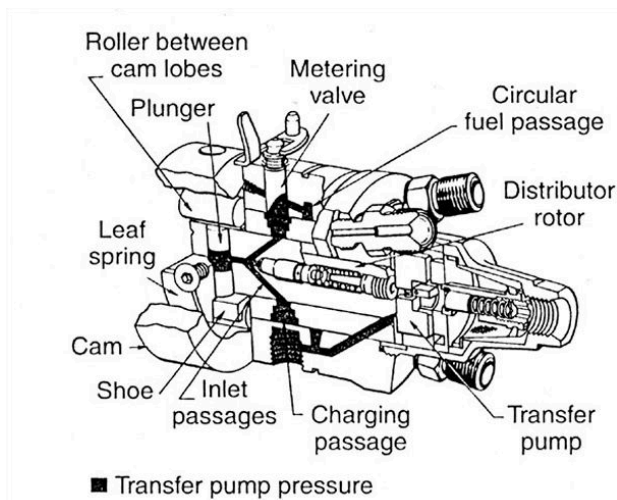

Bodybuilders and athletes use Sustanon 250 to improve their physique and sports These injections are given once every three It is an oil-based solution that contains Arachis oil, so it is not sustainable for anyone who has an allergy to soy or

Testosterone Sustanon 250: Side Effects and Typical Gains

(Answer)

$$\frac{\theta - \theta_s}{\theta_0 - \theta_s} = \frac{185 - 70}{250 - 70} = 0.638 \text{ in accordance with Fig.6.1 } \frac{a \cdot t_{co}}{\ell^2} = 0.07 \quad t_{co} = \frac{0.07 \ell^2}{a}$$

$$\frac{0.07 \times 6^2}{0.075} = 33.6 \text{ seconds, } \frac{x}{a} = \frac{1.5}{3} = 0.5 \text{ in accordance with Fig.6.1 } \frac{t_c}{t_{co}} = 0.4$$

Therefore $t_c = 0.4 t_{co} = 0.4 \times 33.6 = 13.4$

The temperature at the center at that time is calculated from $a \cdot t_c / \ell^2 = 0.075 \times 13.4 / 6^2 = 0.028$

In accordance with Fig.6.1 $(\theta - \theta_s) / (\theta_0 - \theta_s) = (\theta - 70) / (250 - 70) = 0.93 \quad \theta = 237^\circ\text{C}$,

Side effects start to occur when bodybuilders use sustanon 250 to sky rocket test levels so he/she can experience dramatic muscle The side effects of sustanon 250 are similar to dianabol, with them having a similar chemical However, sustanon 250 will have more androgen-based side effects due to its higher

Sustanon 250 - Guide A-Z

Beginner sustanon 250 cycle plan Many people who start their adventure with steroids decide to go on a 10 week In my opinion it is definitely too short and only makes sense in the case of The other most popular testosterone esters take about 4-5 weeks to be 100% It gives about 5-6 weeks of real mass building on the

You All Wanted to Know About Sustanon 250 Dosage



The Best Sustanon 250 Cycle The typical Sustanon 250 cycle is for four to eight weeks, and it is necessary to use Arimidex to protect yourself from the various side Generally, people prefer the Sustanon 250 stack cycle because stacking gives them more effective Here is the best example of Sustanon solo and stack cycle example:

Sustanon 250 is Utilized To Cope With Confirmed Testosterone Deficiency

Melt Temperature (°F)	600°F
(°C)	315°C
Mold Temperature (°F)	(275)
(°C)	(135)
Injection Steps	3.556 cm/s (1.4 ips)

It raises testosterone levels in adult males and helps to improve various health problems including impotence, infertility, low sex drive, fatigue, and Sustanon 250 Beligas Pharmaceuticals is one of the most popular injectable steroids with the trade name Cycle 1 vial single product \$ 120 Add to cart Description Brand

[Previous Page](#) - [Next Page](#)